



**EJOT®**

**Super-SAPHIR® JT3  
and EJOFAST JF3  
bi-metal self-drilling  
fasteners**

**for the construction and  
solar industries**

# EJOT Super-SAPHIR®

## Self-Drilling Fasteners JT3



### PRODUCT GROUP

EJOT Super-SAPHIR® fasteners are manufactured from 304 (A2) grade austenitic stainless steel with a hardened carbon steel drill point welded to the stainless steel shank.

### DESIGN

The hardened drill point enables the screw to drill carbon steel sections and by having the lead threads formed on this hardened point this allows for correct tapping at high drilling speed.

### ASSEMBLY

Where specified they are assembled with a stainless steel / EPDM vulcanized sealing washer every time.

### FINISH

These fasteners are zinc coated for aesthetic reasons and waxed to lubricate the surface during installation.

### EJOT product codes explained:

## Super-SAPHIR® JT 3 - 2 - D x L - S5/8

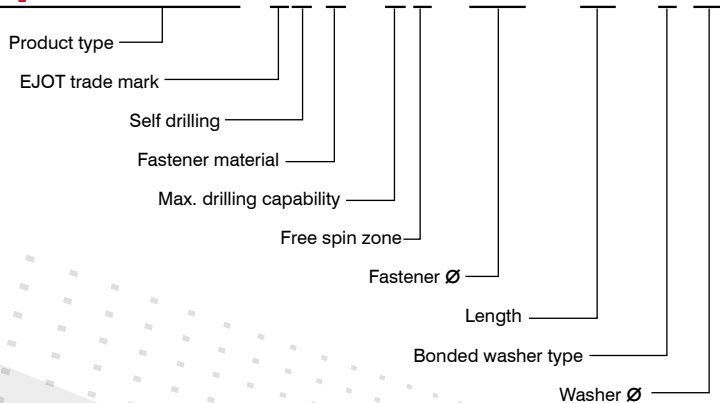

# EJOFAST

## Self-Drilling Fasteners JF3

### PRODUCT GROUP

The new EJOFAST JF3 fastener utilizes advanced fastening technology for fixing thin metal to thin metal. Manufactured from 304 (A2) grade austenitic stainless steel with a unique carbon pierce-point tip welded to the stainless steel shank.

### DESIGN

EJOFAST's 10 and 12 gauge diameter (4.8mm and 5.5mm) utilize a buttress thread design, delivering high pullout strengths.

### ASSEMBLY

Where specified they are assembled with a stainless steel / EPDM vulcanized sealing washer ensuring a safe seal every time.

### FINISH

These fasteners are zinc coated and waxed to lubricate the surface during installation.

### INSTALLATION

EJOFAST goes exactly where it should go – no skating on the surface. Installation also 'feels' equally smooth. Multiple time tests at a drive speed of 1650 rpm with an end loading of 44lbs clearly showed EJOFAST to be on average 30% faster than a standard stitcher. This means significant man-hours saved on any moderate to large installation.

### CLEAN, TIGHT JOINT

By displacing, as opposed to cutting the metal, this innovative thread creates no debris and swarf. Displaced metal is forced forward - creating a tighter joint. On site, the removal of swarf should be 'good housekeeping' practice. 'Overlooked' swarf soon turns to unsightly rust.

Tensometer testing shows that the EJOFAST JF3 offers an improved pullout resistance advantage of 30% over conventional stitchers.

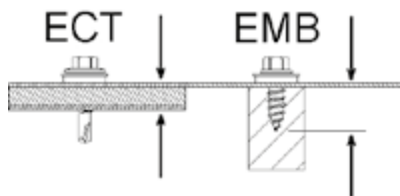



### Effective Clamping Thickness

(ECT) is the total thickness of the build up to be fixed.

### Embedment

(EMB) figures relate to depth into substrate (not including clamp pieces).

### Key to fasteners:



-  without washer
-  with washer

**EJOT Super-SAPHIR® Stainless Steel Bi-Met Self-Drilling Fasteners**

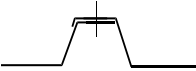
**JF3-2 Series**

 <p><b>Application</b> Laps of roofing or cladding sheets and flashings Drill Point 1 18 Threads Per inch</p> 	Item ID	Product Code	Item description / Metric	Item description / Standard	Box Qty	
				<b>JF3-2 Series</b>	<b>JF3-2 Series</b>	
	6000	7380628301	EJOFAST JF3-2H-4.8 x 19	JF3-2-#10 x 3/4" - DP1	500	
	6001	3591977391	EJOFAST JF3-2H-4.8 x 19-E14	JF3-2-#10 x 3/4" S5/8 - DP1	500	
	6002	7380639301	EJOFAST JF3-2-5.5 x 25	JF3-2-#12 x 1" - DP1	500	
	6003	3597211391	EJOFAST JF3-2-5.5 x 25-E16	JF3-2-#12 x 1" S5/8 - DP1	500	
	6004	7380644301	EJOFAST JF3-2-5.5 x 35	JF3-2-#12 x 1 3/8" - DP1	500	
	6005	3597211391	EJOFAST JF3-2-5.5 x 35-E16	JF3-2-#12 x 1 3/8" S5/8 - DP1	500	

**JT3-2 Series for thin metal sheet**

 <p><b>Application</b> Laps of roofing or cladding sheets and flashings Drill Point 1 14 Threads Per Inch</p> 	Item ID	Product Code	Item description / Metric	Item description / Standard	Box Qty	
				<b>JT3-2 Series</b>	<b>JT3-2 Series</b>	
	6006	7380496301	JT3-2H-4.8 x 19	JT3-2-#10 x 3/4 - DP1	1,000	
	6007	3591977351	JT3-2H-4.8 x 19-E14	JT3-2-#10 x 3/4 S5/8 - DP1	1,000	
	6008	7380598301	JT3-2H-Plus 5.5 x 25	JT3-2-#12 x 1" - DP1	500	
	6009	3592211351	JT3-2H-Plus 5.5 x 25-E16	JT3-2-#12 x 1" S5/8 - DP1	500	
	6010	7380614301	JT3-2H-Plus 5.5 x 35	JT3-2-#12 x 1-3/8" DP1	500	
	6011	3592511391	JT3-2H-Plus 5.5 x 35 E16	JT3-2-#12 x 1-3/8" S5/8 -DP1	500	
	6012	7380499301	JT3-2 - 6.0 x 25	JT3-2-#13 x 1 - DP1	500	
	6013	3595511321	JT3-2 - 6.0 x 25 E16	JT3-2-#13 x 1 S5/8 - DP1	500	
	6014	7380633301	JT3-2 -6.0 x 35	JT3-2-#13 x 1-3/8" - DP1	500	
	6015	3595711321	JT3-2 -6.0 x 35 E16	JT3-2-#13 x 1-3/8" S5/8 - DP1	500	
	6016	7380515301	JT3-2-6.3 x 25	JT3-2-#14 x 1" - DP1	500	
	6017	3599411321	JT3-2-6.3 x 25-E16	JT3-2-#14 x 1" S5/8 - DP1	500	

**EJOT Super-SAPHIR® Counter Sunk Butress Thread For Thin Metal Sheet & Timber**

**JT3-ST2 Series**

 <p><b>Application</b> Standing seam halter brackets - Steel sections from .028 - .063" in thickness Drill and tap capacity .028 - .063" Drill and tap capacity .55 - 1.5mm Drill Point 1 12.7 Threads Per Inch</p>	Item ID	Product Code	Item description / Metric	Item description / Standard	Box Qty	
				<b>JT3-ST2- 6</b>	<b>JT3-ST2- 13 - DP1</b>	
	6018	7382125301	JT3-ST2 - 6 x 60	JT3-ST2-#13 x 2-3/8" - DP1	250	
	6019	7382107301	JT3-ST2 - 6 x 80	JT3-ST2-#13 x 3-1/8" - DP1	250	
	6020	7382101301	JT3-ST2- 6 x 100	JT3-ST2-#13 x 4" - DP1	250	
	6021	7382102301	JT3-ST2 - 6 x 120	JT3-ST2-#13 x 4-3/4" - DP1	200	
	6022	7382103301	JT3-ST2 - 6 x 140	JT3-ST2-#13 x 5-1/2" - DP1	150	
	6023	7382104301	JT3-ST2 - 6 x 160	JT3-ST2-#13 x 6-1/4" - DP1	150	
	6024	7382105301	JT3-ST2 - 6 x 180	JT3-ST2-#13 x 7" - DP1	150	
	6025	7382106301	JT3-ST2 - 6 x 200	JT3-ST2-#13 x 8" - DP1	150	



### JT3-X Series



**Application**

Standing seam halter brackets  
 Drill and tap capacity .028 - .063"  
 Drill and tap capacity 0.5 - 1.5mm  
 Drill Point 1  
 12.7 Threads Per Inch

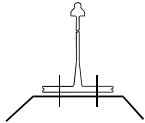

Item ID	Product Code	Item description / Metric	Item description / Standard	Box Qty
		<b>JT3-X</b>	<b>JT3-X</b>	
6026	7380539301	JT3-X2-6.0 x 25	JT3-X2-#13 x 1" - DP1	500
6027	7380516301	JT3-X2-6.0 x 36	JT3-X2-#13 x 1-5/8" - DP1	500
6028	7380517301	JT3-X2-6.0 x 46	JT3-X2-#13 x 1-7/8" - DP1	500
6029	7380654301	JT3-X4-6.0 x 50	JT3-X4-#13 x 2" - DP2	500
6030	7382121301	JT3-X2-6.0/25 C/SK Tile Batten	JT3-X2-#13 x 2-3/8" - DP1	500

### JT3-2 Series Timber



**Application**

Roofing or cladding steel or aluminum sheets  
 - Timber  
 Mechanical performance is dependant on embedment and grade of timber  
 Drill Point 1  
 14 Threads Per Inch

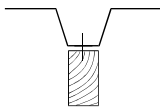

Item ID	Product Code	Item description / Metric	Item description / Standard	Box Qty
		<b>JT3-2-6.5 Timber</b>	<b>JT3-2-#1/4 Timber DP1</b>	
6031	7380335301	JT3-2-6.5 x 50	JT3-2- #1/4 x 2" - DP1	250
6032	3598811321	JT3-2-6.5 x 50 E16	JT3-2- #1/4 x 2" S5/8 - DP1	250
6033	7380524301	JT3-2-6.5 x 65	JT3-2- #1/4 x 2-5/8" - DP1	250
6034	3598911321	JT3-2-6.5 x 65 E16	JT3-2- #1/4 x 2-9/16" S5/8 - DP1	250
6035	7380553301	JT3-2-6.5 x 80	JT3-2- #1/4 x 3-1/8" - DP1	200
6036	3598011321	JT3-2-6.5 x 80 E16	JT3-2- #1/4 x 3-1/8" S5/8 - DP1	250
6037	7380538301	JT3-2-6.5 x 100	JT3-2- #1/4 x 4" - DP1	200
6038	3598111321	JT3-2-6.5 x 100 E16	JT3-2- #1/4 x 4" S5/8 - DP1	200
6039	7380472301	JT3-2-6.5 x 120	JT3-2- #1/4 x 4-3/4" - DP1	150
6040	3598311321	JT3-2-6.5 x 120 E16	JT3-2- #1/4 x 4-3/4" S5/8 - DP1	150
6041	7380473301	JT3-2-6.5 x 140	JT3-2- #1/4 x 5-1/2" - DP1	150
6042	3598511321	JT3-2-6.5 x 140 E16	JT3-2-#1/4 x 5-1/2" S5/8 - DP1	150
6043	7380474301	JT3-2-6.5 x 160	JT3-2- #1/4 x 6-3/8" - DP1	150
6044	3598711321	JT3-2-6.5 x 160 E16	JT3-2- #1/4 x 6-3/8" S5/8 - DP1	150
6045	7380541301	JT3-2-6.5 x 180	JT3-2- #1/4 x 7" - DP1	100
6046	3598211321	JT3-2-6.5 x 180 E16	JT3-2- #1/4 x 7" S5/8 - DP1	100
6047	7380542301	JT3-2-6.5 x 200	JT3-2- #1/4 x 7-7/8" - DP1	100
6048	3599011321	JT3-2-6.5 x 200 E16	JT3-2- #1/4 x 7-7/8" S5/8 - DP1	100
	3599111321	JT3-2-6.5x220-E16	JT3-2-1/4 x 8-1/4 - DP1	100
	3599211321	JT3-2-6.5x240-E16	JT3-2-1/4 x 9-3/8 - DP1	100
	3599311321	JT3-2-6.5x260-E16	JT3-2-1/4 x 10-1/4 - DP1	100
	3599511321	JT3-2-6.5x280-E16	JT3-2-1/4 x 11 - DP1	100
	3599611321	JT3-2-6.5x300-E16	JT3-2-1/4 x 11-4/5 - DP1	100

# EJOT SAPHIR® Self-Drilling Fasteners JT3

## JT3-3 Series



### Application

Roofing or cladding  
steel or aluminum  
sheets

Drill and tap  
capacity .047 - .118"

Drill and tap  
capacity 1.2 - 3mm

Drill Point 2  
14 Threads  
Per Inch

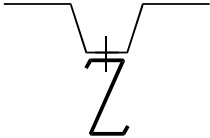

Item ID	Product Code	Item description / Metric	Item description / Standard	Box Qty
		<b>JT3-3-5.5</b>	<b>JT3-3-#12 - DP2</b>	
6049	7280300301	JT3-3-5.5 x 25	JT3-3-#12 x 1" - DP2	500
6050	3592211331	JT3-3-5.5 x 25 E16	JT3-3-#12 x 1" S5/8 - DP2	500
6051	7380302301	JT3-3-5.5 x 35	JT3-3-#12 x 1-3/8" - DP2	500
6052	3592511331	JT3-3-5.5 x 35 E16	JT3-3-#12 x 1-3/8" S5/8 - DP2	500
6053	7380303301	JT3-3-5.5 x 50	JT3-3-#12 x 2" - DP2	250
6054	3592811331	JT3-3-5.5 x 50-E16	JT3-3-#12 x 2" S5/8 - DP2	250
6055	7280379301	JT3-3-5.5 x 70	JT3-3-#12 x 2-3/4" - DP2	250
6056	3593911331	JT3-3-5.5 x 70 E16	JT3-3-#12 x 2-3/4" S5/8 - DP2	250

Item ID	Product Code	Item description / Metric	Item description / Standard	Box Qty
		<b>JT3-3-6.3</b>	<b>JT3-3-#14 - DP2</b>	
6057	7380511301	JT3-3-6.3 x 38	JT3-3-#14 x 1-1/2" - DP2	500
6058	3599611331	JT3-3-6.3 x 38 E16	JT3-3- #14 x 1-1/2" S5/8 - DP2	500
6059	7380582301	JT3-3-6.3 x 50	JT3-3- #14 x 2" - DP2	500
6060	3599811331	JT3-3-6.3 x 50 E16	JT3-3- #14 x 2" S5/8 - DP2	500

**JT3-6 Series**



**Application**

Roofing or cladding steel or aluminum sheets

- Steel sections from .059 - .236" in thickness

\* See bottom of table for 14 x 1, should be used where higher shear load is required

Drill and tap capacity .059 - .236"

Drill and tap capacity 1.5 - 6mm

Drill Point 3  
14 Threads Per Inch

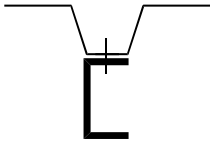

Item ID	Product Code	Item description / Metric	Item description / Standard	Box Qty
		<b>JT3-6-5.5</b>	<b>JT3-6-#12 - DP3</b>	
6061	7380306301	JT3-6-5.5 x 25	JT3-6-#12 x 1" - DP3	500
6062	3572211361	JT3-6-5.5 x 25-E16	JT3-6-#12 x 1" S5/8 - DP3	500
6063	7380307301	JT3-6-5.5 x 30	JT3-6- #12 x 1-1/4" - DP3	500
6064	3572311361	JT3-6-5.5 x 30 E16	JT3-5-#12 x 1-1/4" S5/8 - DP3	500
6065	7380308301	JT3-6-5.5 x 35	JT3-6-#12 x 1-3/8" - DP3	500
6066	3572511361	JT3-6-5.5 x 35-E16	JT3-6-#12 x 1-3/8" S5/8 - DP3	500
6067	7380309301	JT3-6-5.5 x 50	JT3-6- #12 x 2" - DP3	250
6068	3592811361	JT3-6-5.5 x 50 E16	JT3-6- #12 x 2" S5/8 - DP3	250
6069	7380383301	JT3-6-5.5 x 70	JT3-6- #12 x 2-3/4" - DP3	250
6070	3593911361	JT3-6-5.5 x 70-E16	JT3-6-#12 x 2-3/4" S5/8 - DP3	250
6071	7380384301	JT3-6-5.5 x 90	JT3-6- #12 x 3-1/2" - DP3	200
6072	3596111361	JT3-6-5.5 x 90 E16	JT3-6- #12 x 3-1/2" S5/8 - DP3	200
6073	7380385301	JT3-6-5.5 x 110	JT3-6- #12 x 4-3/8" - DP3	200
6074	3596211361	JT3-6-5.5 x 110 E16	JT3-6- #12 x 4-3/8" S5/8 - DP3	200
6075	7380386301	JT3-6-5.5 x 130	JT3-6- #12 x 5-1/8" - DP3	200
6076	3596311361	JT3-6-5.5 x 130 E16	JT3-6- #12 x 5-1/8" S5/8 - DP3	200
6077	7380548301	JT3-6-5.5 x 150	JT3-6- #12 x 6" - DP3	150
6078	3596411361	JT3-6-5.5 x 150 E16	JT3-6- #12 x 6" S5/8 - DP3	150
6079	7380549301	JT3-6-5.5 x 170	JT3-6- #12 x 6-3/4" - DP3	150
6080	3596511361	JT3-6-5.5 x 170 E16	JT3-6- #12 x 6-3/4" S5/8 - DP3	150
6081	7380550301	JT3-6-5.5 x 190	JT3-6- #12 x 7-1/2" - DP3	100
6082	3596611361	JT3-6-5.5 x 190 E16	JT3-6- #12 x 7-1/2" S5/8 - DP3	100
		<b>JT3-6-6.3</b>	<b>JT3-6-#14 - DP3</b>	
6083	7280510301	JT3-6-6.3 x 25	JT3-6-#14 x 1 - DP3	500
6084	3599411361	JT3-6-6.3 x 25-E16	JT3-6-#14 x 1 S5/8 - DP3	500

**EJOT Super-SAPHIR® Light/Medium Section High Thread Fasteners**

**JT3-D6H Series**



**Application**

Steel profiled insulated sandwich panels  
 - Steel sections from 0.047 - .236" in thickness  
 Drill and tap capacity .059 - .236"  
 Drill and tap capacity 1.2 - 6mm  
 Drill Point 3  
 14 Threads Per Inch

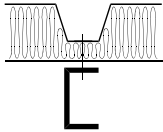

Item ID	Product Code	Item description / Metric	Item description / Standard	Box Qty
		<b>JT3-D6H-5.5/6.3</b>	<b>JT3-D6H-#12/14 - DP3</b>	
6085	7380500301	JT3-D6H-5.5/6.3 x 67	JT3-D6H-#12/14 x 2-5/8" - DP3	250
6086	3554511372	JT3-D6H-5.5/6.3 x 67 E16	JT3-D6H-#12/14 x 2-5/8" S5/8- DP3	250
6087	7380425301	JT3-D6H-5.5/6.3 x 87	JT3-D6H-#12/14 x 3-3/8" - DP3	200
6088	3556011371	JT3-D6H-5.5/6.3 x 87 E16	JT3-D6H-#12/14 x 3-3/8" S5/8- DP3	200
6089	7380426301	JT3-D6H-5.5/6.3 x 107	JT3-D6H-#12/14 x 4-1/4" - DP3	200
6090	3556111371	JT3-D6H-5.5/6.3 x 107 E16	JT3-D6H-#12/14 x 4-1/4" S5/8- DP3	200
6091	7380427301	JT3-D6H-5.5/6.3 x 127	JT3-D6H-#12/14 x 5" - DP3	150
6092	3556211371	JT3-D6H-5.5/6.3 x 127 E16	JT3-D6H-#12/14 x 5" S5/8- DP3	150
6093	7380428301	JT3-D6H-5.5/6.3 x 147	JT3-D6H-#12/14 x 5-7/8" - DP3	150
6094	3556311371	JT3-D6H-5.5/6.3 x 147 E16	JT3-D6H-#12/14 x 5-7/8" S5/8 - DP3	150
6095	7380543301	JT3-D6H-5.5/6.3 x 167	JT3-D6H-#12/14 x 6-1/2" - DP3	150
6096	3556711371	JT3-D6H-5.5/6.3 x 167 E16	JT3-D6H-#12/14 x 6-1/2" S5/8 - DP3	150
6097	7380493301	JT3-D6H-5.5/6.3 x 197	JT3-D6H-#12/14 x 7-7/8" - DP3	100
6098	3559711372	JT3-D6H-5.5/6.3 x 197 E16	JT3-D6H-#12/14 x 7-7/8" S5/8 - DP3	100
6099	7380568301	JT3-D6H-5.5/6.3 x 237	JT3-D6H-#12/14 x 9-3/8" - DP3	100
6100	3559611372	JT3-D6H-5.5/6.3 x 237 E16	JT3-D6H-#12/14 x 9-3/8" - DP3	100
		JT3-D-6H-5.5/6.3x267	JT3-D6H-12/14 x 10-1/2 - DP3	100
	3559911372	JT3-D-6H-5.5/6.3x267-E16	JT3-D6H-12/14 x 10-1/2 S5/8 - DP3	100

**JT3-18-5.5**



**Application**

Fastening profiled steel and aluminium sheet and sandwich panels to 4-16 mm steel substructure  
 - Fastening profiled aluminium sheet and sandwich panels to 4-18 mm aluminium substructure



Item ID	Product Code	Item description / Metric	Item description / Standard	Box Qty
	3593011381	JT3-18-5.5x55-E16	JT3-18-12 x 2-1/8" - DP7	100



**EJOT Super-SAPHIR® Heavy Section High Thread Fasteners**

**JT3-D12H Series**



**Application**

Steel faced insulated sandwich panels  
 - Steel sections from 0.157 - .472" in thickness  
 Drill and tap capacity .157 - .472"  
 Drill and tap capacity 4 - 12mm  
 Drill Point 5  
 14 Threads Per Inch

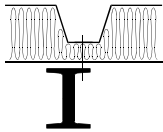

Item ID	Product Code	Item description / Metric	Item description / Standard	Box Qty
		<b>JT3-D12H-5.5/6.3</b>	<b>JT3- D12H-#12/14 - DP5</b>	
6101	7380501309	JT3-D12H-5.5/6.3 x 75	JT3-D12H-#12/14 x 3 - DP5	250
6102	3557511312	JT3-D12H-5.5/6.3 x 75 E16	JT3-D12H-#12/14 x 3 S5/8 - DP5	250
6103	7380455309	JT3-D12H-5.5/6.3 x 95	JT3-D12H-#12/14 x 3-3/4" - DP5	200
6104	3554911311	JT3-D12H-5.5/6.3 x 95 E16	JT3-D12H-#12/14 x 3-3/4" S5/8 - DP5	200
6105	7380456301	JT3-D12H-5.5/6.3 x 115	JT3-D12H-#12/14 x 4-1/2" - DP5	200
6106	3555211311	JT3-D12H-5.5/6.3 x 115 E16	JT3-D12H-#12/14 x 4-1/2" S5/8- DP5	200
6107	7380432309	JT3-D12H-5.5/6.3 x 135	JT3-D12H-#12/14 x 5-3/8" - DP5	150
6108	3555411311	JT3-D12H-5.5/6.3 x 135 E16	JT3-D12H-#12/14 x 5-3/8" S5/8 - DP5	150
6109	7380457309	JT3-D12H-5.5/6.3 x 155	JT3-D12H-#12/14 x 6-1/4" - DP5	150
6110	3555711311	JT3-D12H-5.5/6.3 x 155 E16	JT3-D12H-#12/14 x 6-1/4" S5/8 - DP5	150
6111	7380518309	JT3-D12H-5.5/6.3 x 175	JT3-D12H-#12/14 x 6-7/8" - DP5	150
6112	3556511312	JT3-D12H-5.5/6.3 x 175 E16	JT3-D12H-#12/14 x 6-7/8" S5/8- DP5	150
6113	7380502309	JT3-D12H-5.5/6.3 x 195	JT3-D12H-#12/14 x 7-6/8" - DP5	150
6114	3559511312	JT3-D12H-5.5/6.3 x 195 E16	JT3-D12H-#12/14 x 7-6/8" S5/8 - DP5	150
6115	7380569301	JT3-D12H-5.5/6.3 x 245	JT3-D12H-#12/14 x 9-6/8" - DP5	100
6116	3559811312	JT3-D12H-5.5/6.3 x 245 E16	JT3-D12H-#12/14 x 9-6/8" S5/8 - DP5	100
	3557311312	JT3-D-12H-5.5/6.3x275-E16	JT3-D12H-12/14 x 11 S5/8 - DP5	100
	3557411312	JT3-D-12H-5.5/6.3x300-E16	JT3-D12H-12/14 x 12 S5/8 - DP5	100

**EJOT Super-SAPHIR® Heavy Section Fasteners**

**JT3-12 Series**



**Application**

Roofing or cladding steel or aluminum sheets  
 - Steel sections from 0.157 - .472" in thickness  
 Drill and tap capacity .157 - .472"  
 Drill and tap capacity 4 - 12mm  
 Drill Point 5  
 14 Threads Per Inch

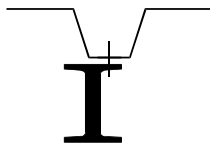

Item ID	Product Code	Item description / Metric	Item description / Standard	Box Qty
		<b>JT3-D12H-5.5/6.3</b>	<b>JT3- D12H-#12/14 - DP5</b>	
6117	7380477309	JT3-12-5.5x40	JT3-12-12 x 1-1/2"	500
6118	3595611311	JT3-12-5.5x40-E16	JT3-12-12 x 1-1/2" S5/8	500
6119	7380627309	JT3-12-5.5x58	JT3-12-12 x 2-1/4"	250
6120	3595811311	JT3-12-5.5x58-E16	JT3-12-12 x 2-1/4" S5/8	250
	7380554309	JT3-12-5.5x78	JT3-12-12 x 3"	250
	3595011311	JT3-12-5.5x78-E16	JT3-12-12 x 3" S5/8	250
	7380555309	JT3-12-5.5x98	JT3-12-12 x 4"	100
	3595111311	JT3-12-5.5x98-E16	JT3-12-12 x 4" S5/8	100
	7380556309	JT3-12-5.5x118	JT3-12-12 x 4-5/8"	150
	3595211311	JT3-12-5.5x118-E16	JT3-12-12 x 4-5/8" S5/8	150
	7380557309	JT3-12-5.5x138	JT3-12-12 x 5-3/8"	150
	3595311311	JT3-12-5.5x138-E16	JT3-12-12 x 5-3/8" S5/8	150
	7380558309	JT3-12-5.5x158	JT3-12-12 x 6-1/4"	150
	3595411311	JT3-12-5.5x158-E16	JT3-12-12 x 6-1/4" S5/8	150
	7380559309	JT3-12-5.5x178	JT3-12-12 x 7"	150
	3595511311	JT3-12-5.5x178-E16	JT3-12-12 x 7" S5/8	150
	7380560309	JT3-12-5.5x198	JT3-12-12 x 7-4/5"	100
	3595711311	JT3-12-5.5x198-E16	JT3-12-12 x 7-4/5" S5/8	100

**EJOT Super-SAPHIR® Low Profile Head Self Drilling Fasteners**

**JT3-LT3 Series**

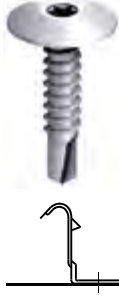

**Application**  
 Clips  
 - Steel section from 0.047 - .118" in thickness  
 Drill and tap capacity .047 - .118"  
 Drill and tap capacity 1.2 - 3mm  
 Drill Point 2  
 14 Threads Per Inch

Item ID	Product Code	Item description / Metric	Item description / Standard	Box Qty
		<b>Ultra LPH JT3- LT3</b>	<b>Ultra LPH JT3-LT3 12- DP2</b>	
6121	7384126301	JT3-3-LT-5.5 x 25	JT3-3-#12 x 1" Low Profile - DP2	1,000

**JT3-FR-2H Series**



**Application**  
 Laps of roofing or cladding sheets and flashings  
 - Laps of roofing or cladding sheets  
 Drill Point 1  
 14 Threads Per Inch

Item ID	Product Code	Item description / Metric	Item description / Standard	Box Qty
		<b>LPH Secondary Fasteners</b>	<b>JT3-FR2- #10/#12/#14</b>	
6122	7381106301	JT3-FR-2H-4.8 x 19	JT3-FR-2H-#10 x 3/4" - DP1	1,000
6123	3591968358	JT3-FR-2H-4.8 x 19 E12	JT3-FR-2H-#10 x 3/4" S1/2 - DP1	1,000
6124	7384165301	JT3-FR-2H-Plus-5.5 x 25	JT3-FR2H+-#12 x 1" - DP1	1,000
6125	3592269398	JT3-FR-2H-Plus-5.5 x 25 E12	JT3-FR2H+-#12 x 1" S1/2 - DP1	1,000
6126	7384137301	JT3-FR-2H-6.3 x 25	JT3-FR-2H- #14 x 1" - DP1	500
6127	3599469358	JT3-FR-2H-6.3 x 25 E12	JT3-FR-2H- #14 x 1" S1/2 DP1	500

**JT3-FR-3 Series**



**Application**  
 Roofing or cladding steel or aluminum sheets  
 - Steel sections from .059 - .118" in thickness  
 Drill and tap capacity .059 - .118"  
 Drill and tap capacity 1 - 3mm  
 Drill Point 2  
 14 Threads Per Inch

Item ID	Product Code	Item description / Metric	Item description / Standard	Box Qty
		<b>LPH Light Section Fasteners</b>	<b>JT3-FR3H- #12 - DP2</b>	
6128	7381126301	JT3-FR-3-5.5 x 50	JT3-FR3H-#12 x 2" - DP2	500
6129	3592869335	JT3-FR-3-5.5 x 50 E12	JT3-FR3H-#12 x 2" S1/2 - DP2	500

**JT3-FR-2 Series**



**Application**  
 Roofing or cladding steel or aluminum sheets  
 - Timber  
 Mechanical performance is dependant on embedment and grade of timber  
 Drill Point 1  
 14 Threads Per Inch

Item ID	Product Code	Item description / Metric	Item description / Standard	Box Qty
		<b>LPH Timber Section Fasteners</b>	<b>JT3-FR2- #10 - DP1</b>	
6130	7381092301	JT3-FR-2-4.9 x 35	JT3-FR-2-#10 x 1-3/8" - DP1	500
6131	3593568328	JT3-FR-2-4.9 x 35 E12	JT3-FR-2-#10 x 1-3/8 " S1/2- DP1	500

### JT3-FR-6 Series



**Application**

Roofing or cladding steel or aluminum sheets  
 - Steel sections from .059 - .236" in thickness  
 Drill and tap capacity .059 - .236"  
 Drill and tap capacity 1.5 - 6mm  
 Drill Point 3  
 14 Threads Per Inch

Item ID	Product Code	Item description / Metric	Item description / Standard	Box Qty
		<b>LPH Light/Medium Section Fasteners</b>	<b>JT3-FR6- #12 - DP3</b>	
6132	7384077301	JT3-FR-6-5.5 x 25	JT3-FR-6-#12 x 1" - DP3	1,000
6133	3592269368	JT3-FR-6-5.5 x 25 E12	JT3-FR-6- #12 x 1" S1/2 - DP3	1,000
6134	7384101301	JT3-FR-6-5.5 x 35	JT3-FR-6- #12 x 1-3/8" - DP3	500
6135	3592569368	JT3-FR-6-5.5 x 35 E12	JT3-FR-6- #12 x 1-3/8" S1/2 - DP3	500

### JT3-FR-12 Series



**Application**

Roofing or cladding steel or aluminum sheets  
 - Steel sections from .157 - .472" in thickness  
 Drill and tap capacity .157 - .472"  
 Drill and tap capacity 4 - 12mm  
 Drill Point 5  
 14 Threads Per Inch

Item ID	Product Code	Item description / Metric	Item description / Standard	Box Qty
		<b>LPH Heavy Section Fasteners</b>	<b>JT3-FR12- #12 - DP5</b>	
6136	7384134301	JT3-FR-12-5.5 x 40	JT3-FR-12- #12 x 1/1/2" - DP5	500
6137	3595669318	JT3-FR-12-5.5 x 40 E12	JT3-FR-12- #12 x 1/1/2" S1/2 - DP5	500

### Other Products

#### Washers

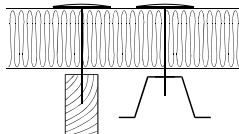

**Application**

Insulation  
 - Plywood, oriented strand board (OSB), timber, cement particle board (check with EJOT Technical), and steel sheet 0.7 - 1.2 mm thick.  
 Please note: 8 mm Hex Drive  
 For timber: Anchor length = Insulation Thickness + Embedment of 40 mm  
 For sheathing panels: Anchor length = insulation thickness + sheathing panel thickness + protrusion of 20 mm  
 Can be supplied assembled or unassembled  
 Also available with stainless steel fastener upon request

Item ID	Product Code	Item description / Metric	Item description / Standard	Box Qty
		<b>SBH-T Tube Washer</b>		
6140	8519035001	SBH-T 65/25	SBH-T 2-9/16" x 1"	100
6141	8781090008	SBL 90 (3.54")	SBL 90 (3.54")	100
6142	8716140008	SBL 140 Plus (5.51")	SBL 140 Plus (5.51")	100

#### Light Duty Anchor for Fixing Signs to Insulation



Item ID	Product Code	Item description / Metric	Item description / Standard	Box Qty
		<b>Light Duty Anchor for Fixing Signs to Insulation</b>		
6143	8788000002	Spiral Dubel Anchor	Spiral Dubel Anchor	10

#### Carbon Steel Hex drive Ultra Low Profile Fastening System

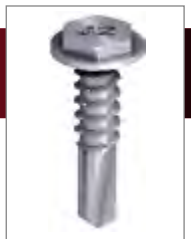

Item ID	Product Code	Item description / Metric	Item description / Standard	Box Qty
		<b>Carbon Steel Hex drive Ultra Low Profile Fastening System</b>		
6138	9900101272	JT2-LH6- 5.5 x 22	JT2-LH6- 12 x 7/8"	POA
6139		8mm LH One piece Socket	8mm LH One piece Socket	1



With over **30 years of experience**, development and **technical expertise**, EJOT understands the requirements for a fastener and its application on building envelopes. Our knowledge provides the base and source of our products and EJOT's solutions offer our customers real benefits.

The quality of our products **surpasses planning laws and legal requirements**. Our aim is to ensure quick and easy assembly.

EJOT USA's and supply base is complemented with **EJOT's global sales and service network** as well as project support teams **ready to help our customers at any time**, nationally and internationally.



[www.ejot-usa.com](http://www.ejot-usa.com)



 [@EJOT\\_USA](https://twitter.com/EJOT_USA)



 [ejotfasteningsystems](https://www.facebook.com/ejotfasteningsystems)

EJOT Fastening Systems LP  
9900 58th Place, Suite 100  
Kenosha, Wisconsin 53144 USA

Tel: 262-612-3550  
Fax: 262-721-1245

Email: [info@ejot-usa.com](mailto:info@ejot-usa.com)

[www.ejot-usa.com](http://www.ejot-usa.com)

**EJOT The Quality Connection**