

# Tap-Flex™ Thread-Forming Structural Screws

Increased thread engagement with strength and ductility

Elco Construction Products has utilized its 25 years of experience in construction fasteners manufacturing to create the new Tap-Flex structural fasteners. These thread-forming screws are dual heat treated, self-tapping fasteners that provide the strength, ductility, and resistance to embrittlement failures required in critical curtain wall and dissimilar metal applications. Tap-Flex fasteners are engineered to replace nut and bolt assemblies and Taptite® fasteners commonly used in building construction.

## Enhanced Thread Design

Tap-Flex screws are threadformers with the patent-pending E-form® segmented thread profile. This design improves both installation and in-place performance:

- Decreases thread-forming torque, easing starting and placement
- Overcomes friction build-up and reduces drive torque
- Increases thread engagement, so it resists back-out and loosening caused by vibration or thermal changes

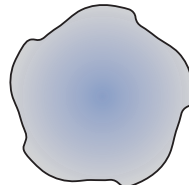

E-Form® Profile

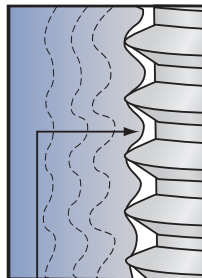

material rolls in to fill space, increasing thread engagement

## Exclusive Flex Technology® Process

Tap-Flex fasteners undergo the unique Flex Technology dual hardening process. The lead tapping threads are selectively hardened to a minimum of HRC 52, easing installation. The load-bearing portion of the fastener is held at or below the critical HRC 34 level. This reduced hardness level also **meets Grade 5 ASTM A449** strength and ductility standards. This helps prevent embrittlement and other structural failures, providing long life high performance in the field.



## Specifications

- Diameters: 3/8", 1/2", and 5/8"
- Lengths: 1-1/2", 2" and 2-1/2"
- Head Style: Hex washer
- Threads: E-Form five-lobe thread forming
- Material: Alloy steel
- Finish: Silver Stalgard® GB coating
- Grade 5: meets ASTM A449 specifications (120 ksi strength)

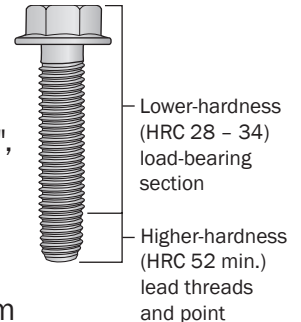

## Features and Benefits









- Eliminates thread-tapping operations
- E-Form configuration overcomes friction build-up and reduces drive torque
- Roll forms own work-hardened thread to resist loosening cause by vibration or thermal changes
- Provides enhanced pull-out performance
- Well-suited for metal applications such as steel and aluminum
- Flex Technology heat treat provides required strength and ductility
- Virtually immune to delayed embrittlement failures
- Stalgard GB coating provides 1000 hours of salt spray resistance (per ASTM B117)
- Accept standard nuts and washers if required

AutoCAD® drawings available to ease design and specification.



Made in the U.S.A.

**Selection Guide\***

	Size	Head/Drive	Catalog No.	Finish	Qty./Box	Load-Bearing Length	Drill Bit Size
<b>3/8" Diameter Anchors with 9/16" Hex Washer Head</b>							
	3/8-16 x 1-1/2	9/16" HWH	ESU310	Stalgard GB	500	1.00"	11/32"
	3/8-16 x 2	9/16" HWH	ESU320	Stalgard GB	500	1.49"	
	3/8-16 x 2-1/2	9/16" HWH	ESU330	Stalgard GB	500	1.99"	
<b>1/2" Diameter Anchors with 3/4" Hex Washer Head</b>							
	1/2-13 x 1-1/2	3/4" HWH	ESU410	Stalgard GB	250	0.875"	15/32"
	1/2-13 x 2	3/4" HWH	ESU420	Stalgard GB	250	1.365"	
	1/2-13 x 2-1/2	3/4" HWH	ESU430	Stalgard GB	250	1.865"	
<b>5/8" Diameter Anchors with 3/4" Hex Washer Head</b>							
	5/8-11 x 1-1/2	3/4" HWH	ESU510	Stalgard GB	250	0.800"	19/32"
	5/8-11 x 2	3/4" HWH	ESU520	Stalgard GB	150	1.24"	
	5/8-11 x 2-1/2	3/4" HWH	ESU530	Stalgard GB	150	1.74"	

\*All Tap-Flex screws are 120 KSI min. per ASTM A449

**Performance Data**

**Shear (lbs)**

Dia.	6063 T5 Aluminum			6061 T6 Aluminum			6063 T5 on 1018 Steel				6061 T6 on 1018 Steel			
	1/8	3/16	1/4	1/8	3/16	1/4	1/8	3/16	1/4	3/8	1/8	3/16	1/4	3/8
3/8"	2321	3476	4979	3560	5205	6885	5015	6560	6975	6965	5711	8701	7721	7611
1/2"	2784	3669	5230	4482	6167	8718	4773	6455	8396	8689	6052	9769	13976	13340
5/8"	2696	3775	5455	4216	6768	9292	4558	6196	8290	8060	5967	9577	13124	15309

**Pull Out (lbs)**

Dia.	6063 T5 Aluminum			6061 T6 Aluminum			1018 Steel			
	1/8	3/16	1/4	1/8	3/16	1/4	1/8	3/16	1/4	3/8
3/8"	1311	2365	3281	2080	3805	5981	3501	5986	11440	11862
1/2"	1431	2230	3694	2190	3869	7527	3668	7411	13613	20440
5/8"	1755	2907	4191	2641	5202	8210	4500	8300	16678	26680

**Identification**

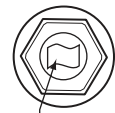

Elco flag in a raised circle

NOTE: All performance data shown is based on tests performed under laboratory conditions. The appropriate safety factor should be applied and code requirements factored into specification and use of these fasteners. Final determination of the appropriate safety factor and use of these fasteners is the sole responsibility of the user, specifying Engineer or other person designing the connection.

For more information, please contact:

**ELCO** **Elco Construction Products**  
 1304 Kerr Drive • Decorah, IA 52101  
**1.800.435.7213** • Fax: 563.387.3540  
**www.elcoconstruction.com**

